

M11.4



M12.8



M13.4 / M13.5



M13.6



M13.7



M13.8



M13.9



M13.10

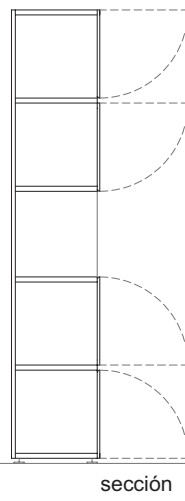
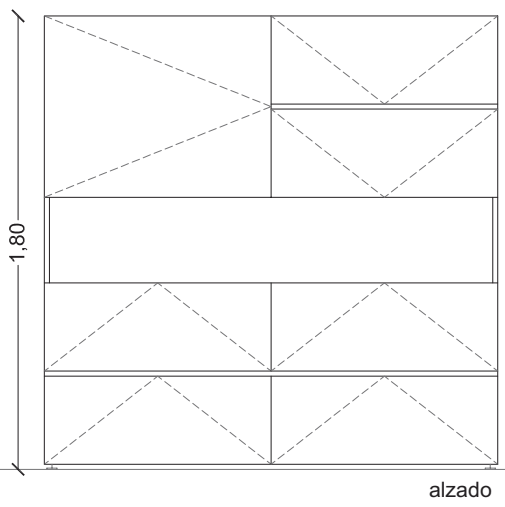
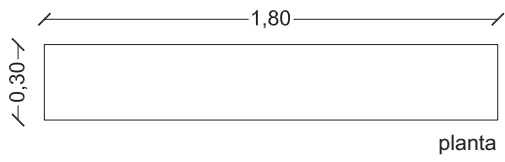

M1.9

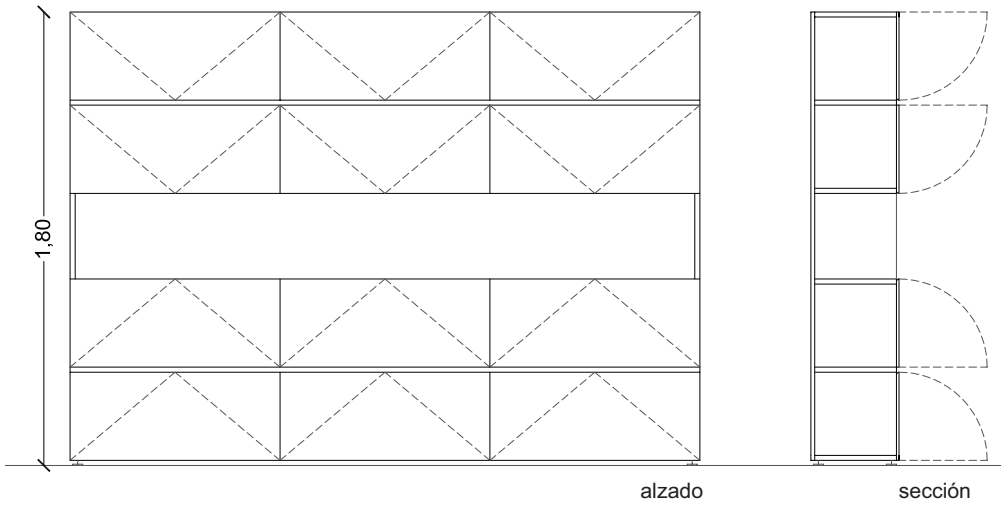
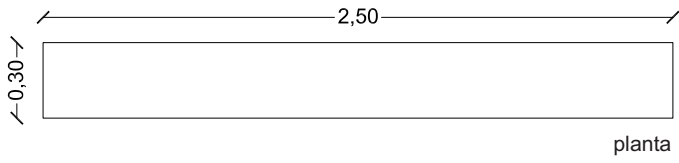

M1.10

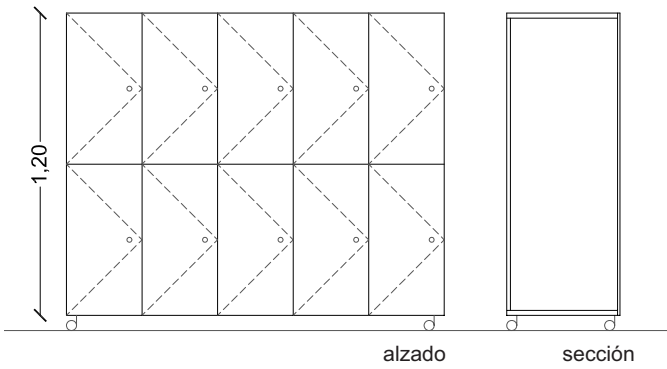
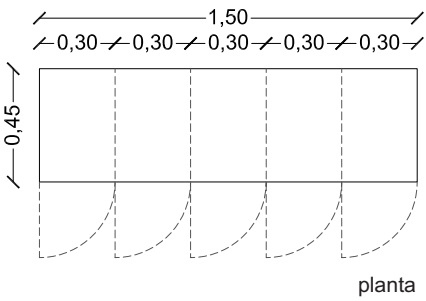

M4.3

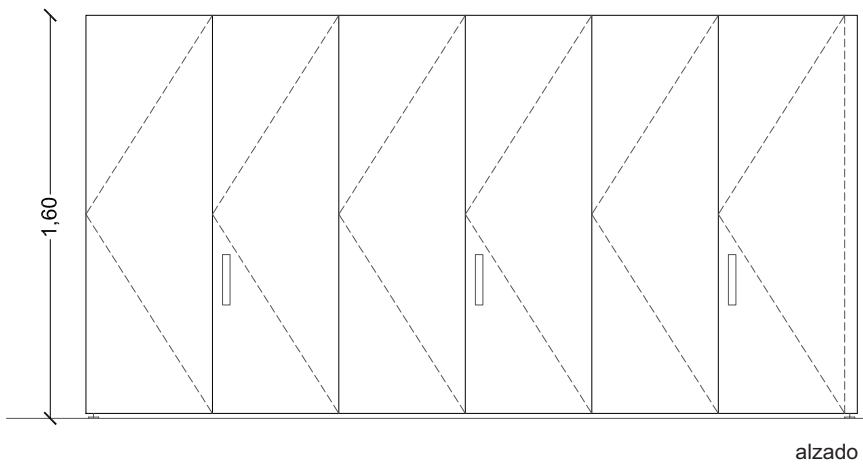
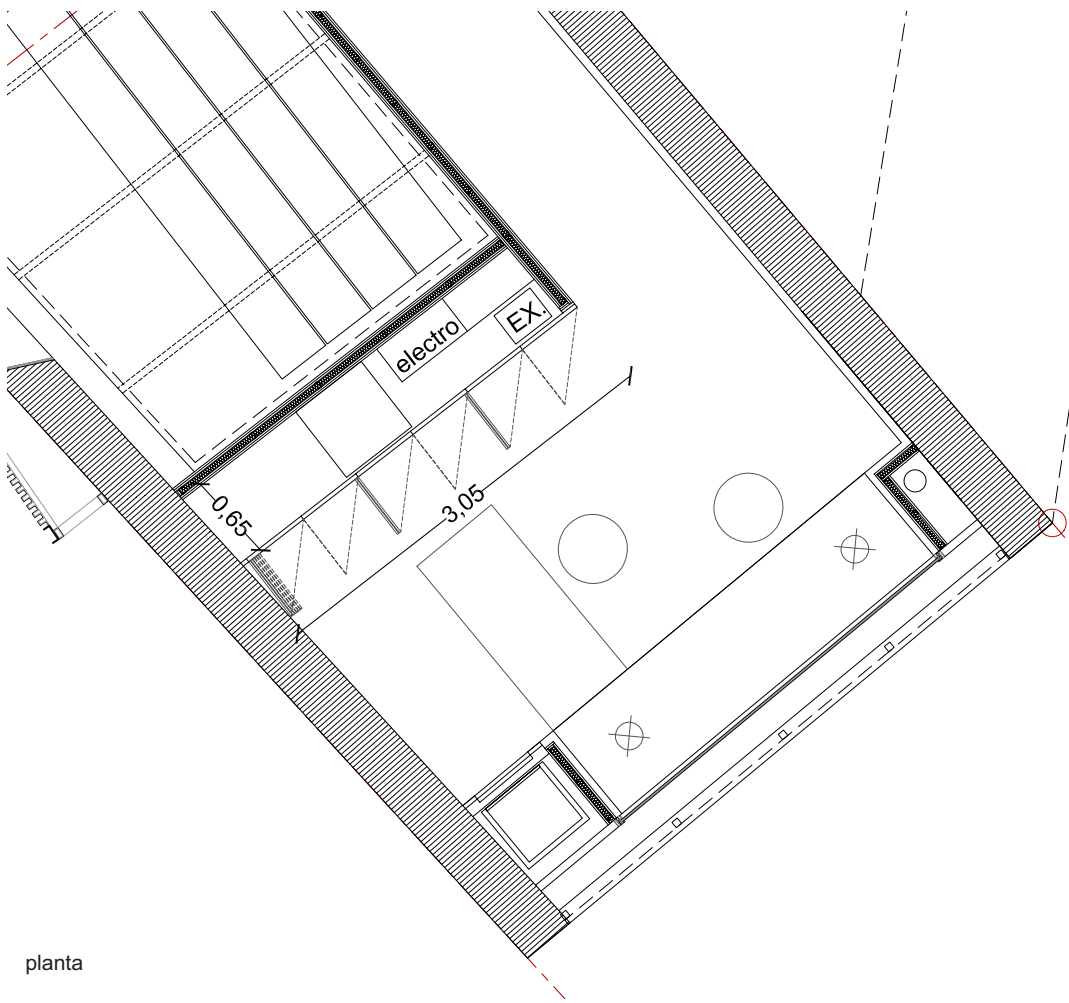

M5.6



huevo para Microondas

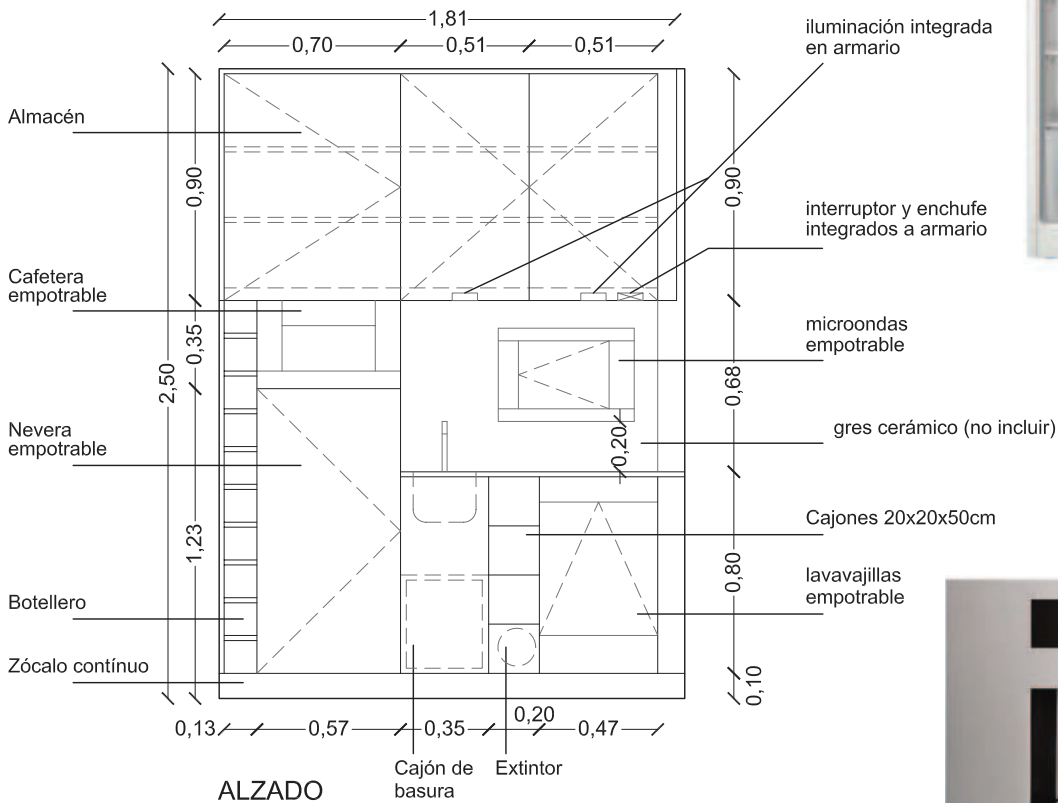
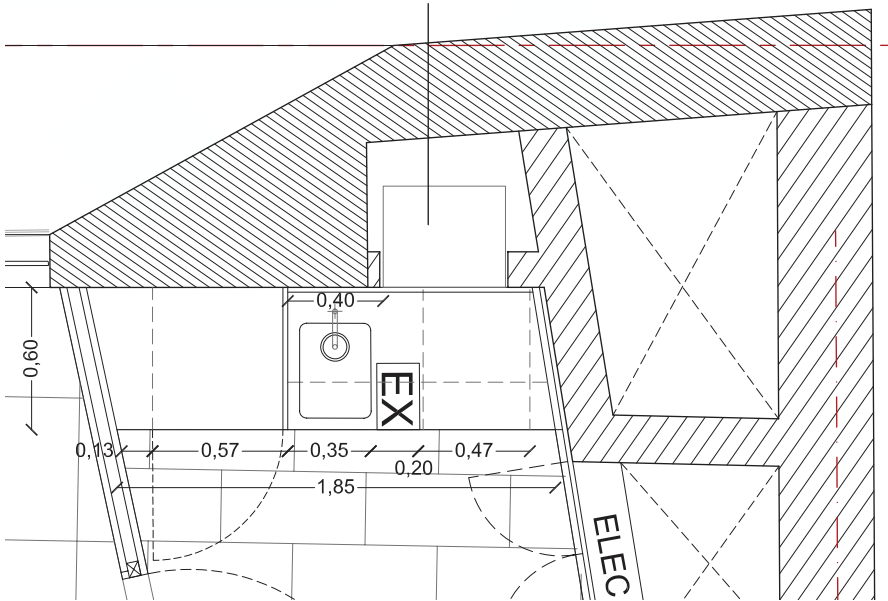

ALZADO



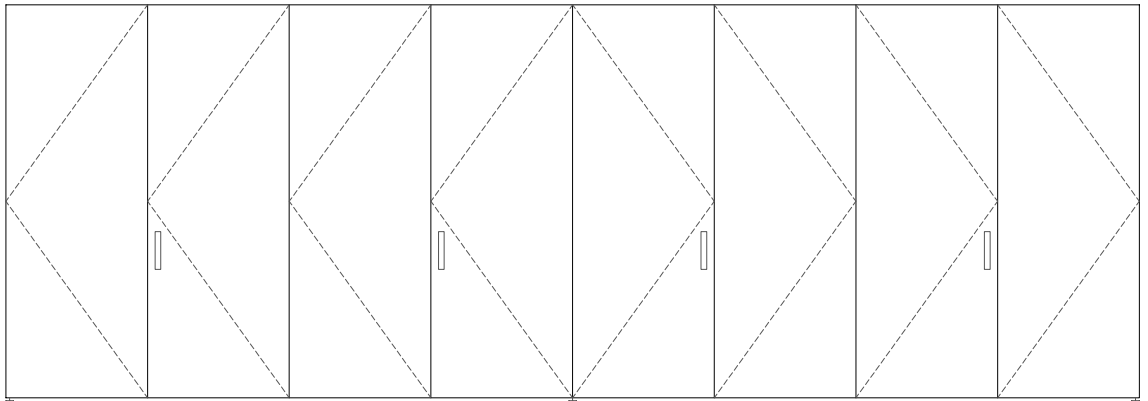

alzado

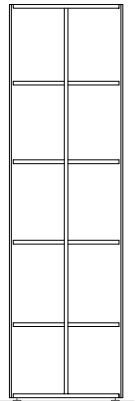

sección transversal estantería

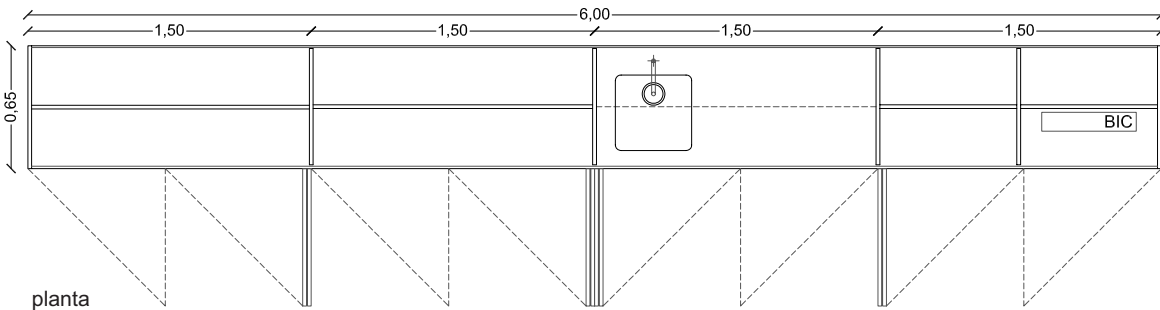

planta

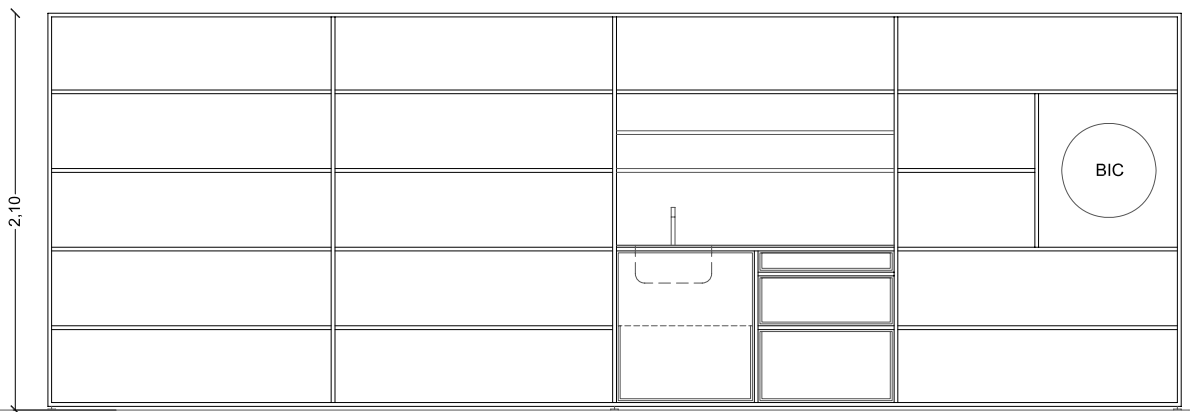

sección longitudinal

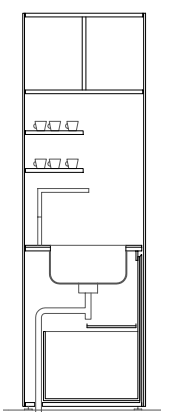

sección transversal cocina

M6.10

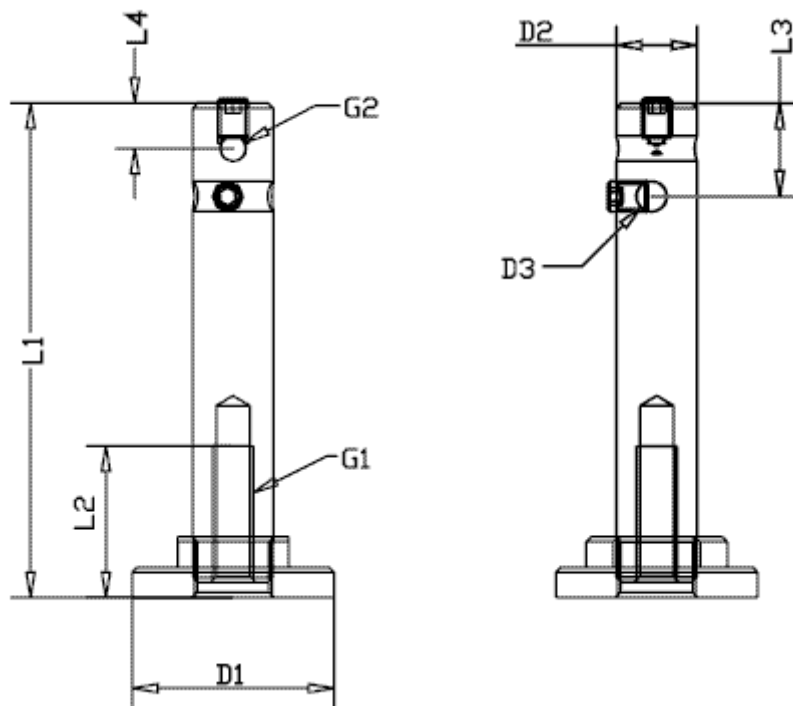

ART. NO.	G1	G2	D1	D2	D3	L1	L2	L3	L4	LOAD	KG/100	PACK
08164095	M8	M6	40.0	16.0	6.0	95	30	19	9	100kg	19.4	

M8.2

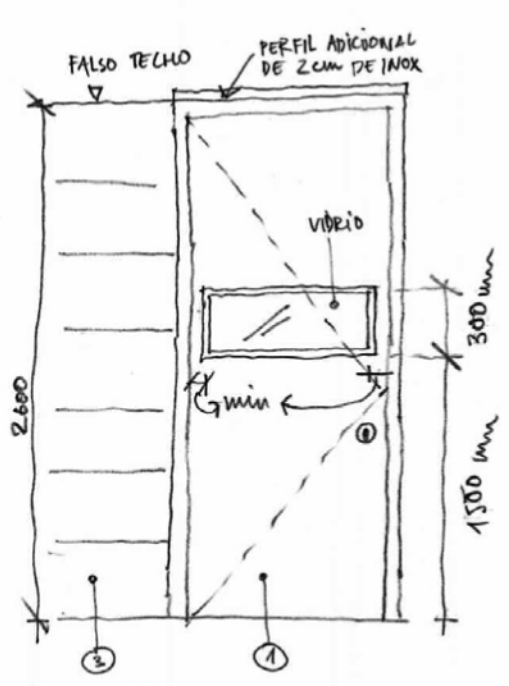

ALZADO PUERTA

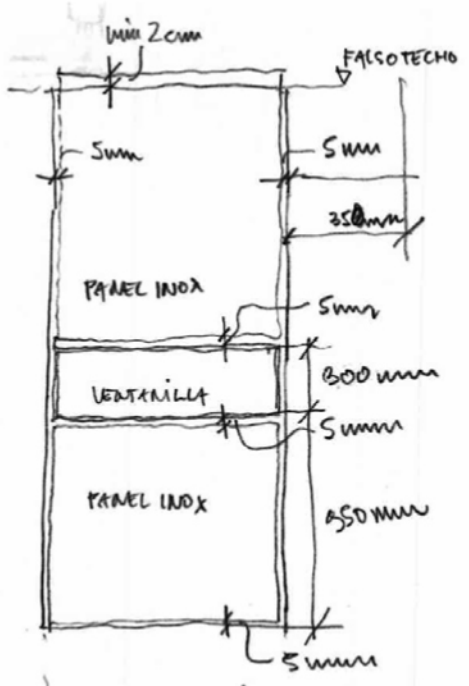

ALZADO VENTANILLA EXTERIOR

- PUERTA LIEVA
MANILLA TIPO TIRADOR AL INTERIOR SOLO!
- LLEVA CERRADURA DE LLAVE
- LLEVA GOMA PARA PREVER SALIDA DE OLORES Y EL RUIDO DE CIERRE DE PUERTAS.
- LLEVA TOPE DE SUELO

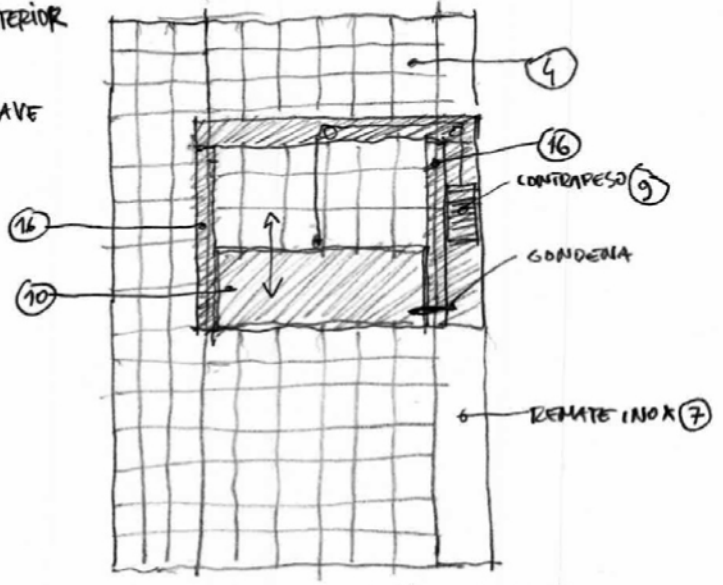

ALZADO VENTANILLA INTERIOR

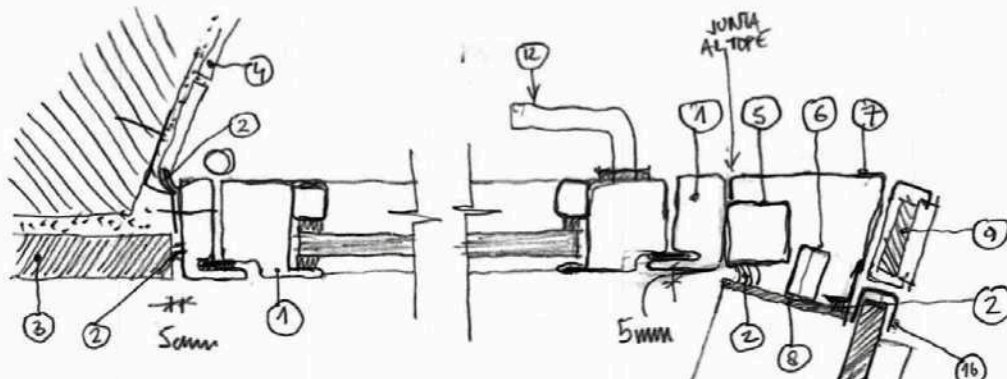

- ① PUERTA INOX CON VENTANA
- ② SELCADO, SIEMPRE RELUENDIDO 5mm!
- ③ PREFABRICADO
- ④ AZULEJOS
- ⑤ TUBO 40,40,2
- ⑥ TUBO 40,20,2
- ⑦ CHAPA INOX E=2mm PLEGADA
- ⑧ MARCO VENTANILLA CHAPA INOX E=4mm
- ⑨ CONTRAPESO
- ⑩ PANEL DE CIERRE DE VENTANILLA, RECUBIERTO A AMBOS LADOS CON CHAPA INOX E=1,5mm, MECANIZADA, CON CONDENA INTERIOR
- ⑪ MURO DE TABIQUE DE 7cm
- ⑫ MANILLA TIPO TIRADOR
- ⑬ PERFIL "U" DE INOX 20,20,2mm
- ⑭ VIDRIO CORREDERA
- ⑮ PANEL DE MADERA RECUBIERTO CON CHAPA INOX E=1,5mm, FIJACION OCULTA
- ⑯ GUIAS LATERALES PARA PANEL DE CIERRE DE VENTANILLA

